



Einfach. Sicher.



LEISTUNGSERKLÄRUNG

DoP: 0063

für Upat Einschlaganker USA (Metallanker zur Verwendung in Beton zur Befestigung von leichten Systemen) – EN

1. Eindeutiger Kenncode des Produkttyps: **DoP: 0063**
2. Verwendungszweck(e): **Für Mehrfachbefestigungen von nichttragenden Systemen in gerissenem und ungerissenem Beton. zur Verwendung in redundanten Systemen zur Befestigung und/oder Verankerung von Bauteilen z.B. leichten abgehängten Decken, sowie von Installationen am bzw. im Beton, siehe Anhang, insbesondere Anhänge B 1 bis B 5**
3. Hersteller: **Upat Vertriebs GmbH, Bebelstraße 11, 79108 Freiburg im Breisgau, Deutschland**
4. Bevollmächtigter: --
5. System(e) zur Bewertung und Überprüfung der Leistungsbeständigkeit: **2+**
6. Europäisches Bewertungsdokument: **ETAG 001; 2011-01**
Europäische Technische Bewertung: **ETA-10/0168; 2017-05-11**
Technische Bewertungsstelle: **DIBt**
Notifizierte Stelle(n): **1343 – MPA Darmstadt**
7. Erklärte Leistung(en):

Mechanische Festigkeit und Standsicherheit (BWR 1), Sicherheit bei der Nutzung (BWR 4)

- **Charakteristischer Widerstand für statische und quasi-statische Einwirkungen, Verschiebungen: Siehe Anhang, insbesondere Anhänge C 1 bis C 2**

Brandschutz (BWR 2)

- **Brandverhalten: Der Dübel erfüllt die Anforderungen der Klasse A 1**
- **Feuerwiderstand: Siehe Anhang, insbesondere Anhang C 3**

8. Angemessene Technische Dokumentation und/oder Spezifische Technische Dokumentation: ---

Die Leistung des vorstehenden Produkts entspricht der erklärten Leistung/den erklärten Leistungen. Für die Erstellung der Leistungserklärung im Einklang mit der Verordnung (EU) Nr. 305/2011 ist allein der obengenannte Hersteller verantwortlich.

Unterzeichnet für den Hersteller und im Namen des Herstellers von:

Andreas Bucher, Dipl.-Ing.

Wolfgang Hengesbach, Dipl.-Ing., Dipl.-Wirtsch.-Ing.

i.V. A. Bucher

i.V. W. Hengesbach

Tumlingen, 2017-05-18

- Diese Leistungserklärung wurde in verschiedenen Sprachversionen erstellt. Für den Fall unterschiedlicher Auslegung hat immer die englische Version Vorrang.

- Der Anhang enthält freiwillige und ergänzende Informationen in englischer Sprache. Diese gehen über die (sprachneutral angegebenen) gesetzlichen Anforderungen hinaus.

Specific Part

1 Technical description of the product

The Upat Drop-in Anchor USA is an anchor made of galvanized or stainless steel which is placed into a drilled hole and anchored by deformation-controlled expansion.

The fixture shall be anchored with a fastening screw or threaded rod.

The product description is given in Annex A.

2 Specification of the intended use in accordance with the applicable European Assessment Document

The performances given in Section 3 are only valid if the anchor is used in compliance with the specifications and conditions given in Annex B.

The verifications and assessment methods on which this European Technical Assessment is based lead to the assumption of a working life of the anchor of at least 50 years. The indications given on the working life cannot be interpreted as a guarantee given by the producer, but are to be regarded only as a means for choosing the right products in relation to the expected economically reasonable working life of the works.

3 Performance of the product and references to the methods used for its assessment

3.1 Mechanical resistance and stability (BWR 1)

The essential characteristics regarding Mechanical resistance and stability are included under the Basic Works Requirement Safety in use.

3.2 Safety in case of fire (BWR 2)

Essential characteristic	Performance
Reaction to fire	Anchorage satisfy requirements for Class A1
Resistance to fire	See Annex C 3

3.3 Safety in use (BWR 4)

Essential characteristic	Performance
Characteristic resistance for static and quasi-static loading, displacements	See Annex C 1 to C 2

4 Assessment and verification of constancy of performance (AVCP) system applied, with reference to its legal base

In accordance with guideline for European technical approval ETAG 001, January 2011 used as European Assessment Document (EAD) according to Article 66 Paragraph 3 of Regulation (EU) No 305/2011 the applicable European legal act is: [97/161/EC].

The system to be applied is: 2+

Multiple use for non-structural applications only

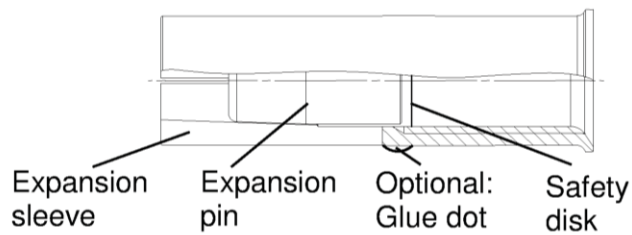
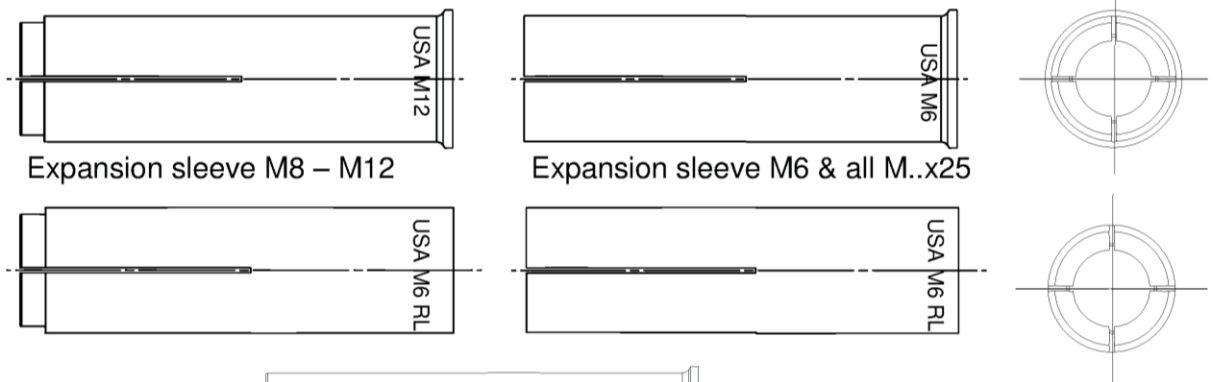

Intended use in concrete

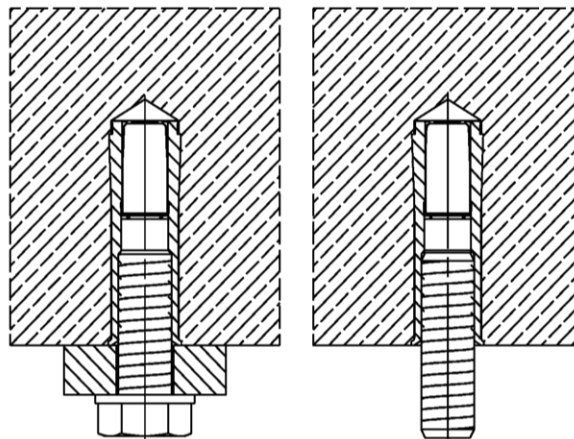

Intended use in precast pre-stressed hollow concrete slabs ($w/e \leq 4,2$) with a flange thickness ≥ 35 (or 30 mm \rightarrow see Annex C2) and only for $h_{ef} = 25$ mm

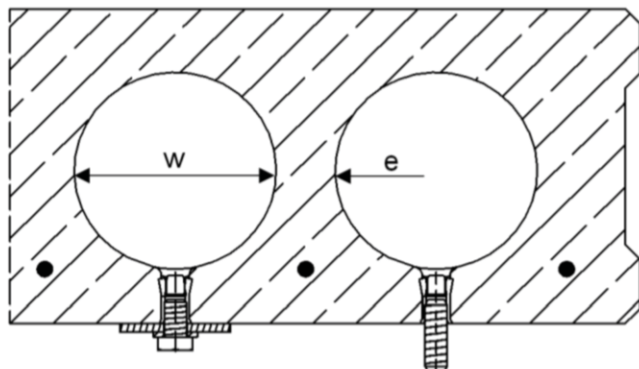

Upat Drop-in Anchor USA

Product description
 Installed condition
 Anchor types

Annex A 1

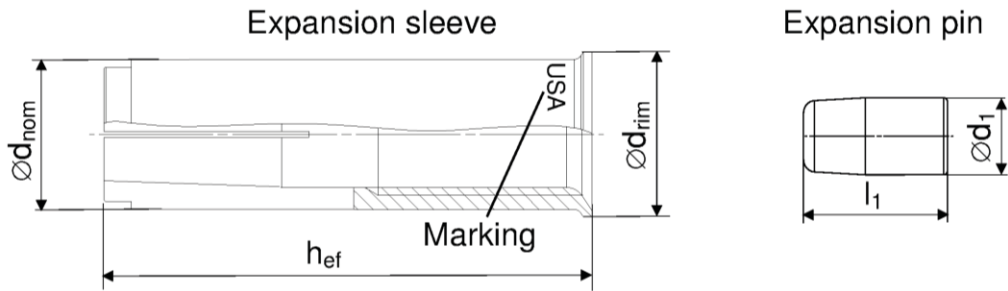

Anchor size USA	M6x25	M6x30	M8x25	M8x30	M8x40	M10x25	M10x30	M10x40	M12x25	M12x50	M12 D
h_{ef} [mm]	25	30	25	30	40	25	30	40	25	50	50
$\varnothing d_{nom}$ [mm]	8		10			12			15		16
$\varnothing d_{rim}$ [mm]	9,5		11,5			13,5			16,5		17,5
$\varnothing d_1$ [mm]	5		6,5			8,5	8		10		
l_1 [mm]	9	14	8	13,5		9	13,5	18,5	10,5	18,5	

Distinctive feature



0x groove for:

- USA M6x30..
- USA M8x30..
- USA M10x40..
- USA M12x50..

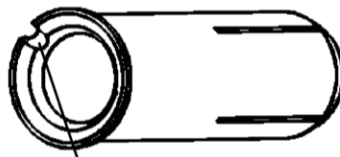

1x groove for:

- USA M6x25..
- USA M8x25..
- USA M10x25..
- USA M12x25..

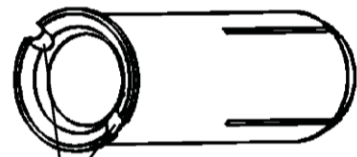

2x groove for:

- USA M8x40..
- USA M10x30..

Marking on anchor body

galvanized steel (gvz)		stainless steel (A4)	
<i>with rim</i>	<i>rimless</i>	<i>with rim</i>	<i>rimless</i>
USA M6x25	USA M6x25 RL	USA M6x30 A4	USA M6x30 RL A4
USA M6x30	USA M6x30 RL	USA M8x30 A4	USA M8x30 RL A4
USA M8x25	USA M8x25 RL	USA M8x40 A4	USA M8x40 RL A4
USA M8x30	USA M8x30 RL	USA M10x30 A4	USA M10x30 RL A4
USA M8x40	USA M8x40 RL	USA M10x40 A4	USA M10x40 RL A4
USA M10x25	USA M10x25 RL	USA M12x50 A4	USA M12x50 RL A4
USA M10x30	USA M10x30 RL	USA M12x50 DA4	USA M12x50 RL DA4
USA M10x40	USA M10x40 RL		
USA M12x25	USA M12x25 RL		
USA M12x50	USA M12x50 RL		
USA M12x50 D	USA M12x50 RLD		

Upat Drop-in Anchor USA

Product description
Anchor types

Annex A 2

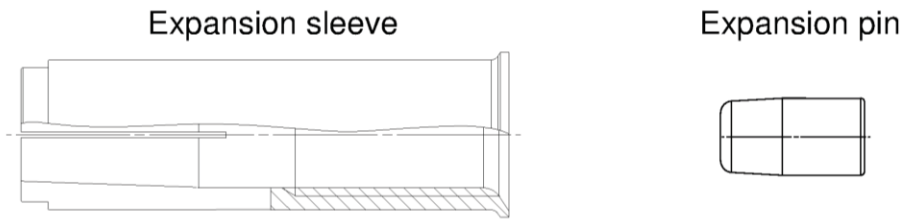

Table A1: Materials

Designation	Material	
	galvanised steel ($\geq 5 \mu\text{m}$)	stainless steel
Expansion sleeve	EN 10277:2008 or EN 10084:2008 or EN 10111:2008 or EN 10263:2001 or EN 10087:1998 or ASTM A29/A29M	EN 10088:2005
Expansion pin		
Fastening screw or threaded rod	steel, property class 4.6, 5.6, 5.8 or 8.8 according to EN ISO 898-1:2012	property class 50, 70 or 80 according to EN ISO 3506:2009

Upat Drop-in Anchor USA

Product description
Material

Annex A 3

Specifications of intended use

Anchorage subject to:

- Static and quasi-static loads
- Only to be used for multiple use for non-structural application
- Fire exposure: only in concrete C12/15 to C50/60, not prestressed hollow concrete slabs

Base materials:

- Reinforced or unreinforced normal weight concrete according to EN 206-1:2000
- Strength classes C12/15 to C50/60 according to EN 206-1:2000
- Precast prestressed hollow concrete slabs with w/e ≤ 4,2 and strength classes C30/37 to C50/60: M6x25, M8x25, M10x25 and M12x25
- Cracked concrete and non-cracked concrete: all sizes

Use conditions (Environmental conditions):

- Structures subject to dry internal conditions (zinc coated steel or stainless steel)
- Structures subject to external atmospheric exposure (including industrial and marine environment) and to permanently damp internal condition, if no particular aggressive conditions exist (stainless steel)

Note: Particular aggressive conditions are e.g. permanent, alternating immersion in seawater or the splash zone of seawater, chloride atmosphere of indoor swimming pools or atmosphere with extreme chemical pollution (e.g. in desulphurization plants or road tunnels where de-icing materials are used)

Design:

- Anchorages are designed under the responsibility of an engineer experienced in anchorages and concrete work
- Verifiable calculation notes and drawings are prepared taking account of the loads to be anchored. The position of the anchor is indicated on the design drawings (e. g. position of the anchor relative to reinforcement or to supports, etc.)
- Anchorages under static or quasi-static actions are to be designed in accordance with:
 - ETAG 001, Annex C, design method B and C, Edition August 2010 or
 - CEN/TS 1992-4:2009, design method B
- Fasteners are only to be used for multiple use for non-structural application, according to: ETAG 001 Part 6, Edition August 2010
- Anchorages under fire exposure are designed in accordance with:
 - EOTA Technical Report TR 020, Edition May 2004
 - CEN/TS 1992-4:2009
 - It must be ensured that local spalling of the concrete cover does not occur

Installation:

- Anchor installation carried out by appropriately qualified personnel and under the supervision of the person responsible for technical matters of the site
- Create drill hole with hammer drill or with hollow drill and vacuum cleaner
- The anchor may only be used once
- Anchor expansion by impact using the setting tools given in Annex B 4. The anchor is property set if the stop of the setting tool reaches the expansion sleeve. The manual setting tool with installation control leaves a visible mark on the sleeve, as illustrated in Annex B4 and B 5

Upat Drop-in Anchor USA	Annex B 1
Intended Use Specifications	

Table B1: Installation parameters for concrete C12/15 to C50/60

Anchor size		M6		M8			M10			M12		M12D	
Nominal drill hole diameter	d_0	[mm]	8	10			12			15		16	
Effective anchorage depth	h_{ef}	[mm]	25	30	25	30	40	25	30	40	25	50	50
Maximum installation torque	max. T_{inst}	[Nm]	4		8			15			35		
Minimum drill hole depth	h_1	[mm]	27	32	27	33	43	27	33	43	27	54	54
Minimum screw-in depth	$l_{s,min}$	[mm]	6		8			10			12		
Maximum screw-in depth	$l_{s,max}$	[mm]	14		14			14		17	14	22	
Clearance hole diameter	$\varnothing d_f \leq$	[mm]	7		9			12			14		
$h_{min} = 80$ mm													
Minimum spacing	s_{min}	[mm]	30	70	70	110	200	80	200		100	-	-
Minimum edge distance	c_{min}	[mm]	60	150	100	150		120	150		130	-	-
$h_{min} = 100$ mm													
Minimum spacing	s_{min}	[mm]	30	65	50	70	60	90	150	100	200		
Minimum edge distance	c_{min}	[mm]	60	115	100	115		100	160	180	110	200	
$h_{min} = 120$ mm													
Minimum spacing	s_{min}	[mm]	30	65	50	70	60	85	95	100	145		
Minimum edge distance	c_{min}	[mm]	60	115	100	115		100	140	150	110	200	

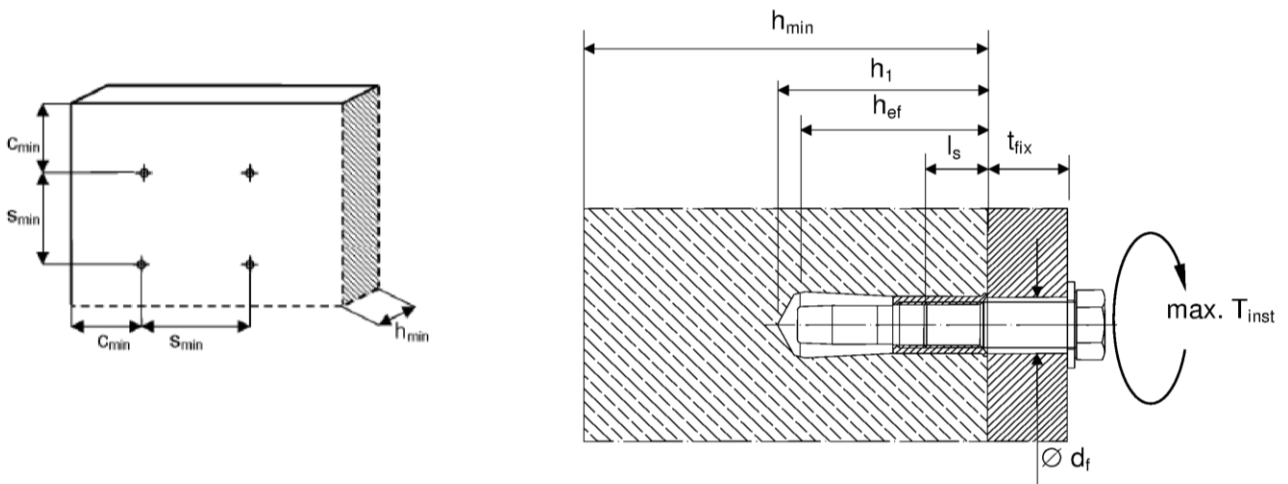

Fastening screw or threaded rod:

- Minimum property class and materials according to table A1
- The length of the fastening screw or threaded rod shall be determined depending on thickness of fixture t_{fix} , admissible tolerances and maximum screw length $l_{s,max}$ as well as minimum screw-in depth $l_{s,min}$.

Upat Drop-in Anchor USA	Annex B 2
Intended Use Installation parameters	

Table B2: Installation parameters for precast pre-stressed hollow concrete slabs

Anchor size			M6	M8	M10	M12
Nominal drill hole diameter	d_0	[mm]	8	10	12	15
Effective anchorage depth	h_{ef}	[mm]	25			
Maximum installation torque	max. T_{inst}	[Nm]	4	8	15	35
Minimum drill hole depth	h_1	[mm]	27			
Minimum screw-in depth	$l_{s,min}$	[mm]	6	8	10	12
Maximum screw-in depth	$l_{s,max}$	[mm]	14			
Clearance hole diameter	$\varnothing d_f$	[mm]	7	9	12	14
Minimum spacing	$s_{min} = s_{cr}$	[mm]	200			
Minimum edge distance	$c_{min} = c_{cr}$	[mm]	150			

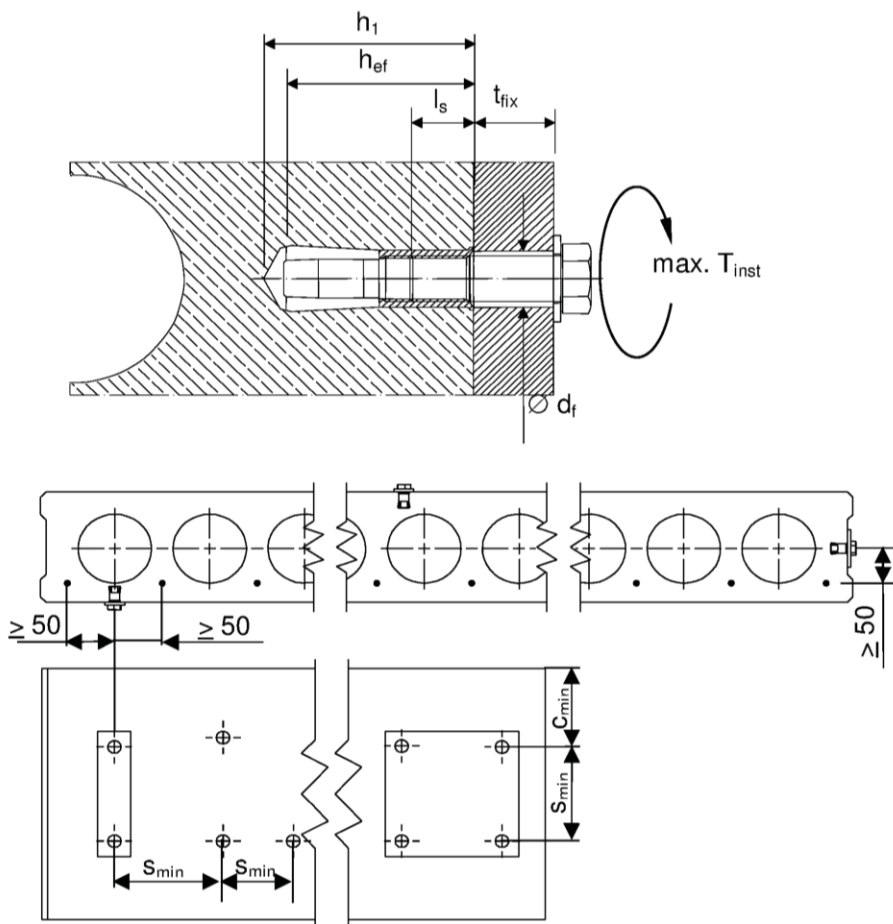

Fastening screw or threaded rod:

- Minimum property class and materials according to table A1
- The length of the fastening screw or threaded rod shall be determined depending on thickness of fixture t_{fix} , admissible tolerances and maximum screw length $l_{s,max}$ as well as minimum screw-in depth $l_{s,min}$.

Upat Drop-in Anchor USA

Intended Use
Installation parameters

Annex B 3

Setting & drilling tools

Setting tools

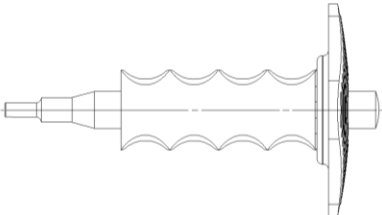
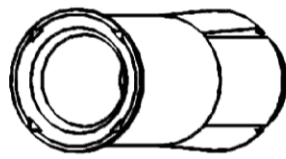
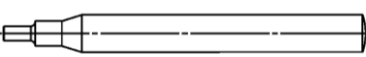
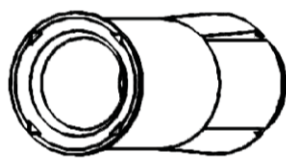
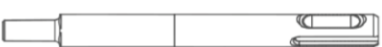
Setting tools	Marking	Description	Marking on USA with rim and rimless
	EHS Plus M..x h _{ef}	Manual setting tool with hand guard	
	EHS M..x h _{ef}	Manual setting tool basic format	
	EMS M..x h _{ef}	Machine setting tool with SDS Plus	No marking

Drilling tools

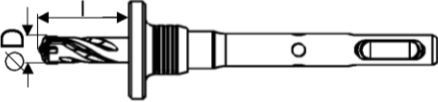
	EBB ∅D x l	Stop drill
Or other usual drillers		

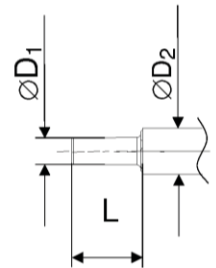

Table B3: Parameters of setting tools

Manual setting tool	Machine setting tool	Stop drill	For anchor size	∅ D1	∅ D2	L
EHS M6x25/30	EMS M6x25/30	EBB 8x25 EBB 8x30	USA M6x25 USA M6x30	4,8	9,0	17,0
EHS M8x25/30	EMS M8x25/30	EBB 10x25 EBB 10x30	USA M8x25 USA M8x30	6,4	11,0	18,0
EHS M8x40	EMS M8x40	EBB 10x40	USA M8x40			28,0
EHS M10x25/30	EMS M10x25/30	EBB 12x25 EBB 12x30	USA M10x25 USA M10x30	7,9	13,0	18,0
EHS M10x40	EMS M10x40	EBB 12x40	USA M10x40			24,0
EHS M12x25	EMS M12x25	EBB 15x25	USA M12x25	10,2	16,5	15,2
EHS M12x50	EMS M12x50	EBB 15x50	USA M12x50	10,2	16,5	30,0
EHS M12x50	EMS M12x50	EBB 16x50	USA M12x50 D			

Upat Drop-in Anchor USA

Intended Use
Setting & Drilling tools

Annex B 4

Installation instructions

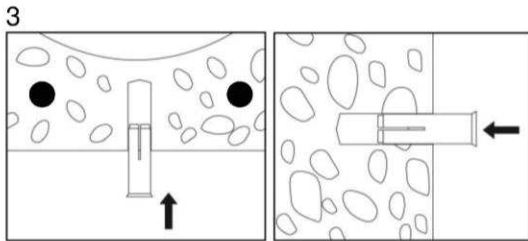
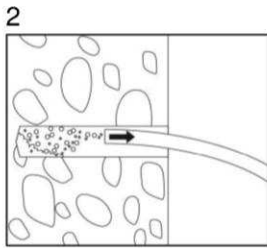
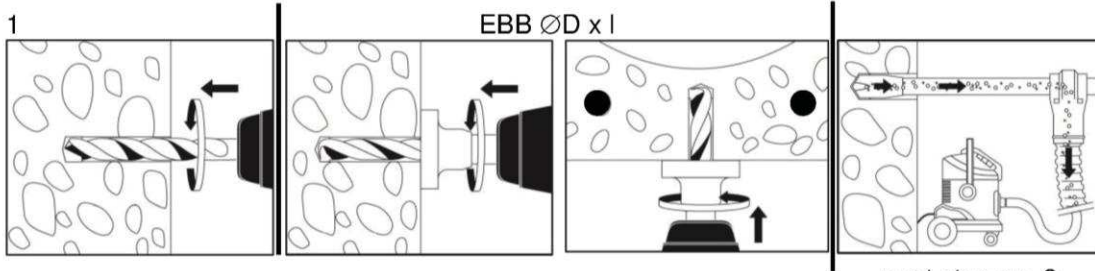

Fixing is not allowed for $h_{ef} = 25 \text{ mm}$ and $d_b < 35 \text{ mm}$ when a cavity is cut!

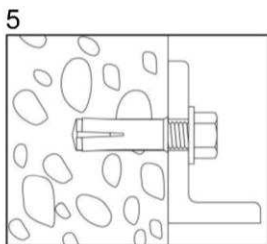
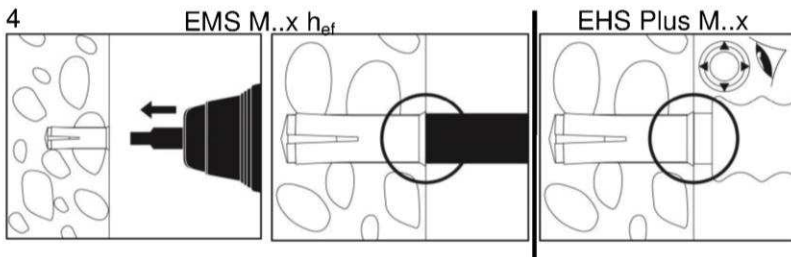
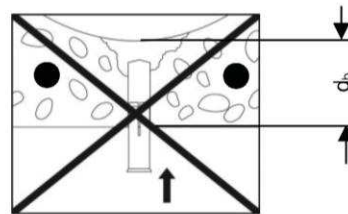

No.	Description
1	Create drill hole with hammer drill or with hollow drill and vacuum cleaner
2	Clean from drill-dust
3	Set anchor till anchor is flush with surface of concrete
4	Expand the sleeve by driving the pin into the sleeve and control the correct setting
5	Fixation of fixture. Maximum installation torque max. T_{inst} must not be crossed

Upat Drop-in Anchor USA

Intended Use
Installation instructions

Annex B 5

Table C1: Characteristic values due to design method B according to ETAG 001, Annex C or design method B according to CEN/TS 1992-4: 2009

Anchor size		Property class screw / rod	M6		M8			M10			M12/ M12D	
Effective anchorage depth	h_{ef} [mm]		25	30	25	30	40	25	30	40	25	50
All load directions												
Characteristic resistance C12/15	F_{RK}^0 [kN]	$\geq A4-50$	-	2	-	3		-	3	5	-	6
		≥ 4.6	1,5		2			3			3	
Characteristic resistance C20/25 to C50/60	F_{RK}^0 [kN]	$\geq A4-50$	-	3	-	5		-	5	7,5	-	9
		≥ 4.6	2		3			4			4	
Installation safety factor	$\gamma_2 = \gamma_{inst}$		1,0	1,2	1,0	1,2		1,0	1,2		1,0	
Characteristic spacing	s_{cr} [mm]		75	90	75	90	120	75	90	200	75	300
Characteristic edge distance	c_{cr} [mm]		38	45	38	45	60	38	45	100	38	150
Steel failure with lever arm												
Characteristic resistance	$M_{RK,s}^0$ [Nm]	A4-50	-	8	-	19		-	37		-	66
Partial safety factor	γ_{Ms}		2,38									
Characteristic resistance	$M_{RK,s}^0$ [Nm]	A4-70	-	11	-	26		-	52		-	92
Partial safety factor	γ_{Ms}		1,56									
Characteristic resistance	$M_{RK,s}^0$ [Nm]	A4-80	-	12	-	30		-	60		-	105
Partial safety factor	γ_{Ms}		1,33									
Characteristic resistance	$M_{RK,s}^0$ [Nm]	4.6	6,1		15			30		52		
Partial safety factor	γ_{Ms}		1,67									
Characteristic resistance	$M_{RK,s}^0$ [Nm]	5.6	7,6		19			37		66		
Partial safety factor	γ_{Ms}		1,67									
Characteristic resistance	$M_{RK,s}^0$ [Nm]	5.8	7,6		19			37		66		
Partial safety factor	γ_{Ms}		1,25									
Characteristic resistance	$M_{RK,s}^0$ [Nm]	8.8	12		30			60		105		
Partial safety factor	γ_{Ms}		1,25									

¹⁾ The anchor is to be used only for multiple use for non-structural applications, the definition of multiple use according to the Member States is given in the informative Annex 1 of ETAG 001 Part 6 (see: www.eota.eu)

²⁾ Characteristic bending moment $M_{RK,s}^0$ for the equation (5.5) in ETAG 001, Annex C respectively Characteristic bending moment $M_{RK,s}^0$ for the equation (D.5) in CEN/TS 1992-4-1

Upat Drop-in Anchor USA

Performances

Characteristic values for tension loads in concrete according to design method B

Annex C 1

Table C2: Characteristic values for $h_{ef} = 25$ mm in precast pre-stressed hollow concrete slabs according to design method C with C30/37 to C50/60

Anchor size	Property class screw / rod	M6	M8	M10	M12
Effective anchorage depth h_{ef} [mm]		25			
All Load directions		galvanised steel; with rim			
Flange thickness d_b [mm]		≥ 35 (or $30^{3)}$)			
Characteristic resistance C30/37 to C50/60 $F_{RK}^{1)}$ [kN]		2	3	4	
Installation safety factor γ_2		1,0			
Characteristic spacing $s_{cr} = s_{min}$ [mm]		200			
Characteristic edge distance $c_{cr} = c_{min}$ [mm]		150			
Steel failure with lever arm					
Characteristic resistance $M_{RK,s}^{0 2)}$ [Nm]	4.6	6,1	15	30	52
Partial safety factor γ_{Ms}		1,67			
Characteristic resistance $M_{RK,s}^{0 2)}$ [Nm]	5.6	7,6	19	37	66
Partial safety factor γ_{Ms}		1,67			
Characteristic resistance $M_{RK,s}^{0 2)}$ [Nm]	5.8	7,6	19	37	66
Partial safety factor γ_{Ms}		1,25			
Characteristic resistance $M_{RK,s}^{0 2)}$ [Nm]	8.8	12	30	60	105
Partial safety factor γ_{Ms}		1,25			

¹⁾ The anchor is to be used only for multiple use for non-structural applications, the definition of multiple use according to the Member States is given in the informative Annex 1 of ETAG 001 Part 6 (see: www.eota.eu)

²⁾ Characteristic bending moment $M_{RK,s}^{0}$ for the equation (5.5) in ETAG 001, Annex C

³⁾ The anchor may be used in a flange thickness of 30 mm with the same characteristic resistance, but the drill hole is not allowed to cut a cavity (see Annex B5 Point 3).
The use of the fischer stop drill EBB is recommended

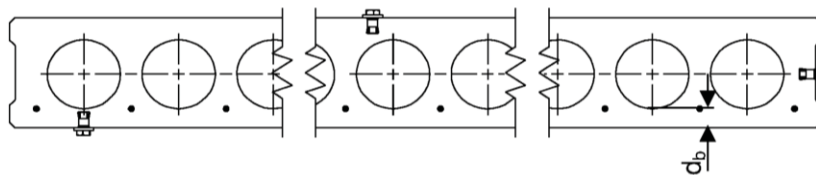

Upat Drop-in Anchor USA

Performances

Characteristic values for tension loads in hollow core slabs according to design method C

Annex C 2

Table C3: Characteristic resistance under fire exposure³⁾ in concrete C20/25 to C50/60 according to design method B, ETAG 001 Annex C or CEN/TS 1992-4: 2009

fire resistance class	USA	property class	M6x25	M6x30	M8x25	M8x30	M8x40	M10x25	M10x30	M10x40	M12x25	M12x50/ M12x50D
			All load directions									
R 30	Characteristic resistance $F_{Rk,fi}^0$ [kN] C20/25 to C50/60	steel ≥ 4.6 or $\geq A4-50^{2)}$	0,5	0,6	0,9	1,3	0,6	0,9	1,8	0,6	2,3	
R 60			0,5	0,6	0,9	0,9	1,5					
R 90			0,4	0,6	0,9	0,6	1,3					
R 120			0,3	0,5	0,6	0,6	0,5					
R 30 – R 120	Characteristic spacing $s_{cr,fi}$ [mm]		100	120	100	120	160	100	120	160	100	200
	Characteristic edge distance $c_{cr,fi}$ [mm]		50	115	50	140	140	50	140	160	50	

¹⁾ In absence of other national regulations, a partial safety factor for the resistance of $\gamma_{m,fi}=1,0$ under fire stress is recommended

²⁾ Not for M..x25

³⁾ Not valid for precast pre-stressed hollow core slabs

Upat Drop-in Anchor USA

Performances
Characteristic loads for fire resistances

Annex C 3